

# User Manual

# puriFlash<sup>®</sup> XS-Vap



**Small, but Mighty**  
**up to 90 samples**

## 2 DOCUMENT APPROVALS

Initiator Name	Department	Date
Benjamin Pionnier	Product manager	01/10/2021

Approver Names		
Jamey Jones	VP, Operation	07/11/2021

### Revision Record

Revision #	Revision Date	DCO#	Description of Change
A	02/22/2022	2022-004	Document creation

<b>1 - General Description</b> .....	<b>page 4</b>
<b>2 - Accessories box</b> .....	<b>page 14</b>
<b>3 - Installation</b> .....	<b>page 14</b>
3.1 - Unpack the system .....	page 14
3.2 - Emplace the system .....	page 15
3.3 - Electrical connection .....	page 15
3.4 - Gas connection .....	page 16
3.5 - Fill water bath .....	page 16
3.6 - Connect the manifold .....	page 17
<b>4 - Operation</b> .....	<b>page 19</b>
4.1 - Control the system .....	page 19
4.2 - Set up the system .....	page 19
4.3 - Start a run .....	page 20
4.4 - End of run .....	page 21
<b>5 - Safety Regulations</b> .....	<b>page 22</b>
<b>6 - Maintenance</b> .....	<b>page 24</b>
6.1 - Clean the nozzles .....	page 24
6.2 - Clean the manifold .....	page 24
6.3 - Clean the water bath .....	page 24
6.4 - Clean the system .....	page 25
6.5 - Long storage .....	page 25
6.6 - Heating temperature calibration .....	page 25
6.7 - Update the control unit .....	page 25
<b>7 - Preventive measures Upkeep schedule</b> .....	<b>page 26</b>
<b>8 - Warranty</b> .....	<b>page 27</b>
<b>9 - List of spare parts</b> .....	<b>page 28</b>
<b>10 - Safety instructions</b> .....	<b>page 29</b>
10.1 - General Safety Instruction .....	page 29
10.2 - Operating compagny's instruction .....	page 30
10.3 - Lid handling .....	page 31
10.4 - Heating .....	page 31
10.5 - Water leakage .....	page 32
10.6 - Exhaust fan .....	page 33
10.7 - Electronical power connection .....	page 33
10.8 - Condensation .....	page 33
10.9 - Regulation gas pressure .....	page 33
<b>11 - Specifications</b> .....	<b>page 34</b>

## 1 - GENERAL DESCRIPTION

PuriFlash® XS-Vap is a new system dedicated to the evaporation and concentration of organic/aqueous solvents.

A wide range of sample sizes and applications are evaporated up to 90 samples in same time.

Thanks to a manual adjustment at the needle position, the samples are evaporated in few minutes while reducing gas consumption and operating costs.

Interchim instrument racks (Gen4, Gen5) for flash purification are compatible with puriFlash® XS-Vap.



The characteristics of the system are:

**Gas supply:** nitrogen or compressed air

**Gas flow consumption:**

- Inlet gas pressure: 3bar

Setting gas pressure (MPa) 0.1MPa = 1bar	0,02	0,05	0,07	0,10	0,13	0,15	0,20	0,25	0,30
GAS CONSUMPTION									
For 56 nozzles (L/min)	19	26	30	44	49	60	73	75	76
For 44 nozzles (L/min)	32	38	48	57	66	74	x	x	x
For 14 nozzles (L/min)	6	11	13	16	18	19	23	28	x
For 6 nozzles (L/min)	3	10	12	15	17	18	22	26	x
For 1 nozzle (L/min)	1	2	4	5	5	5	7	x	x

Recommended pressure

For 56 nozzles: 0.10MPa (Gas Consumption: 44L/min -> around 0.8L/min per nozzle)

For 44 nozzles: 0.05MPa (Gas Consumption: 38L/min -> around 0.8L/min per nozzle)

For 14 nozzles: 0.05MPa (Gas Consumption: 11L/min -> around 0.8L/min per nozzle)

For 6 nozzles: 0.05MPa (Gas Consumption: 11L/min -> around 1.6L/min per nozzle)

For 1 nozzle: 0.02MPa (Gas Consumption: 1L/min -> around 1L/min per nozzle)

- Inlet gas pressure: 1.5bar

Setting gas pressure (MPa) 0.1MPa = 1bar	0,02	0,05	0,07	0,10	0,13	0,15	0,20	0,25	0,30
GAS CONSUMPTION									
For 56 nozzles (L/min)	6	14	33	40	40	42	x	x	x
For 44 nozzles (L/min)	29	36	42	x	x	x	x	x	x
For 14 nozzles (L/min)	2	11	13	16	18	x	x	x	x
For 6 nozzles (L/min)	4	9	11	14	17	x	x	x	x
For 1 nozzle (L/min)	0,9	3	3	4	5	5	x	x	x

Recommended pressure

For 56 nozzles: 0.10MPa (Gas Consumption: 40L/min -> around 0.7L/min per nozzle)

For 44 nozzles: 0.05MPa (Gas Consumption: 38L/min -> around 0.8L/min per nozzle)

For 14 nozzles: 0.05MPa (Gas Consumption: 11L/min -> around 0.8L/min per nozzle)

For 6 nozzles: 0.05MPa (Gas Consumption: 11L/min -> around 1.5L/min per nozzle)

For 1 nozzle: 0.02MPa (Gas Consumption: 1L/min -> around 0.9L/min per nozzle)

**Maximum inlet pressure:** 6bar (0.6Mpa ; 87 psi)

**Maximum Operational Pressure:** 0.2Mpa (2bar ; 29 psi)

**Pressure required for full capacity:** between 0.05 (0.5bar) to 0.1Mpa (1bar)

**Heating bath temp.:** from ambient to 90°C (puriFlash® XS-Vap reaches 40°C in 12 minutes).

**Recommended heating bath temp.:** from ambient to 60°C

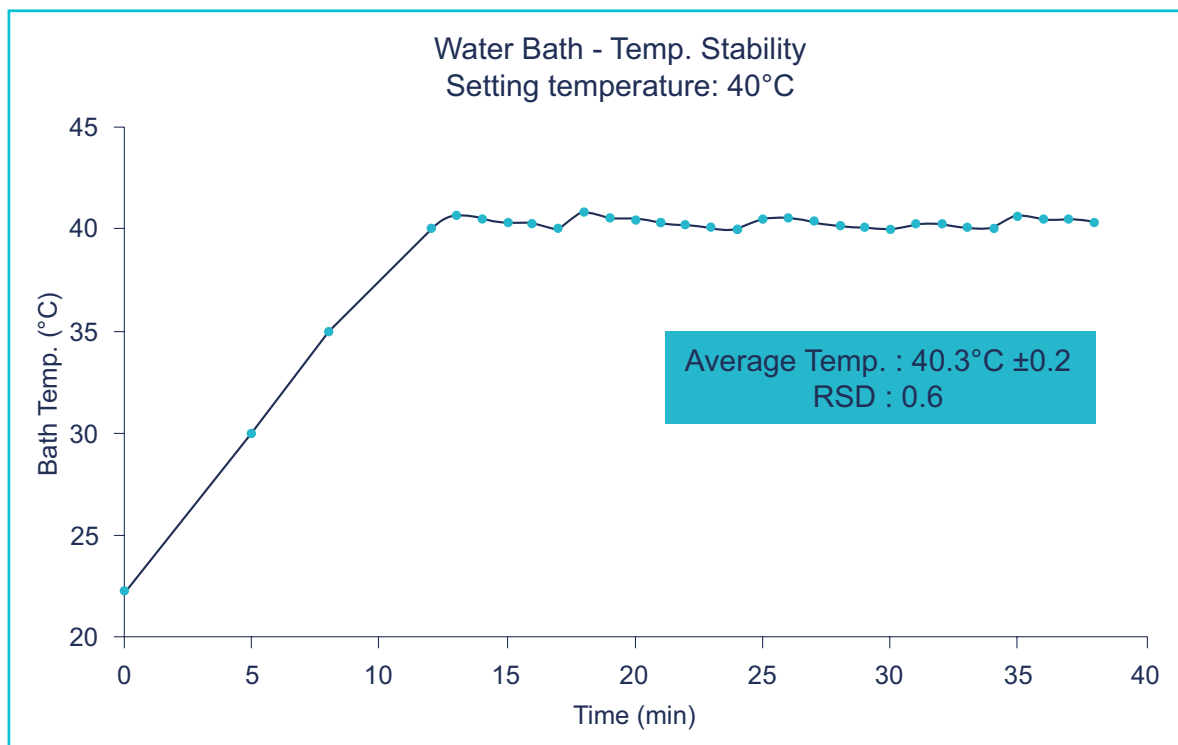

## 1 - GENERAL DESCRIPTION

**Sample volumes:** few mL to 200mL per position

**Tube sizes:** 13x100mm / 16x100mm / 16x150mm / 18x150mm / 18x180mm / 200mL evaporation tubes with 1.0mL end volume / 200mL evaporation tubes without end volume

### Sample Racks:

Tube size	PuriFlash	Capacity	P/N Rack	Manifold	Manifold part number
18x150mm	XS	56	1R8610		
18x180mm	Gen4	44	PF4391	4x14 nozzles	
	Gen5	44	AYHE50		
16x100mm	Gen4	44	PF4381	4x14 nozzles	
16x150mm	Gen5	44	AYHE40		
13x100mm	XS	90	1R8590	5x18 nozzles	
250mL		6	EVAB90	6 nozzles	

The system is delivered with a basket in which we place an adapter for rack test tubes (P/N: EVAA10 ) or rack for glassware 250mL (P/N: EVAB90) .

The basket allows to place the racks inside the water bath.

### - Basket whitout adapter:

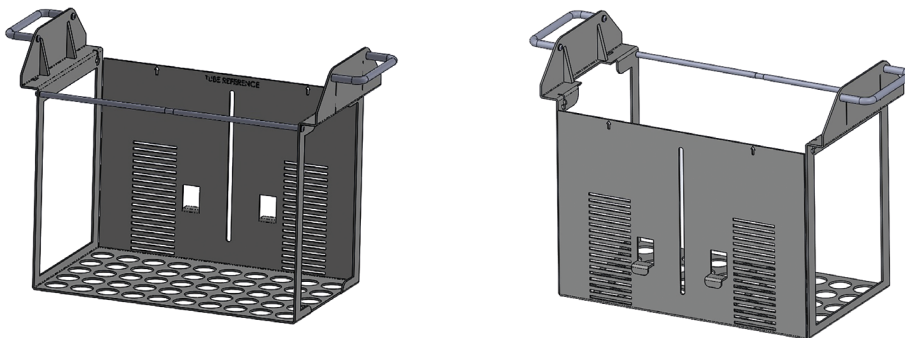

### - Adapter for rack test tubes (up to 90 positions):

This tool is used for rack tubes 12mm, 13mm, 16mm and 18mm OD.

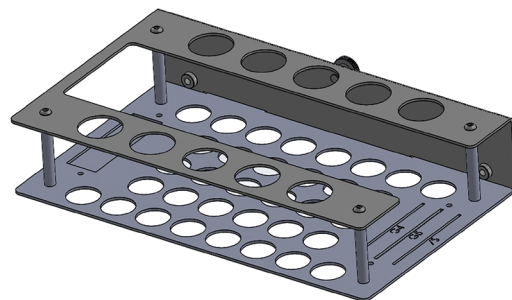

Three engravings indicate the rack position according to the puriFlash models (G4, XS or G5).

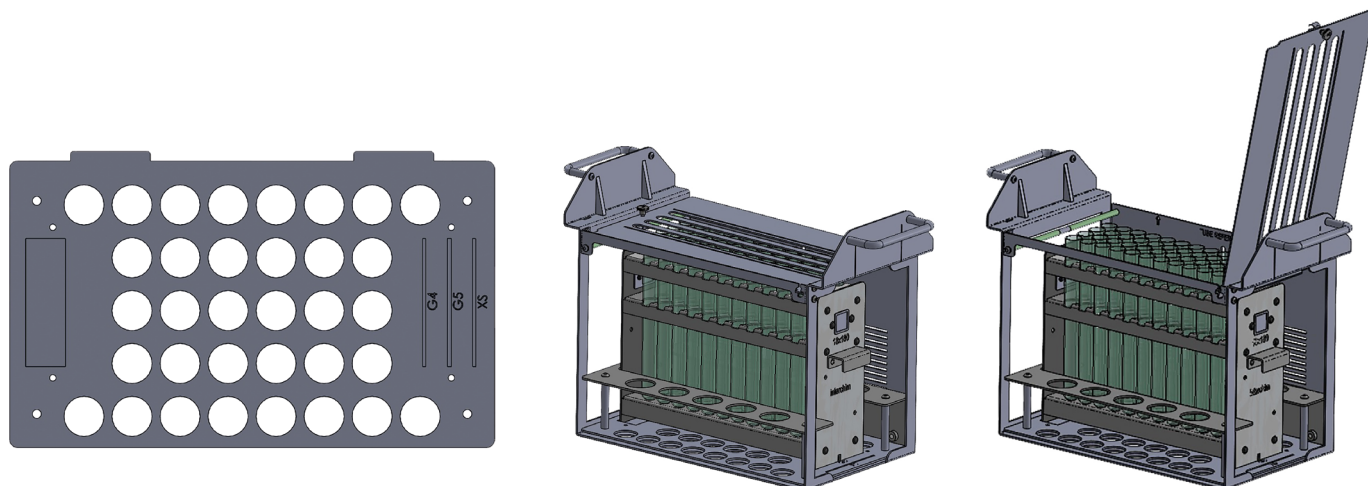

- Adapter for 250mL glassware (up to 6 positions):

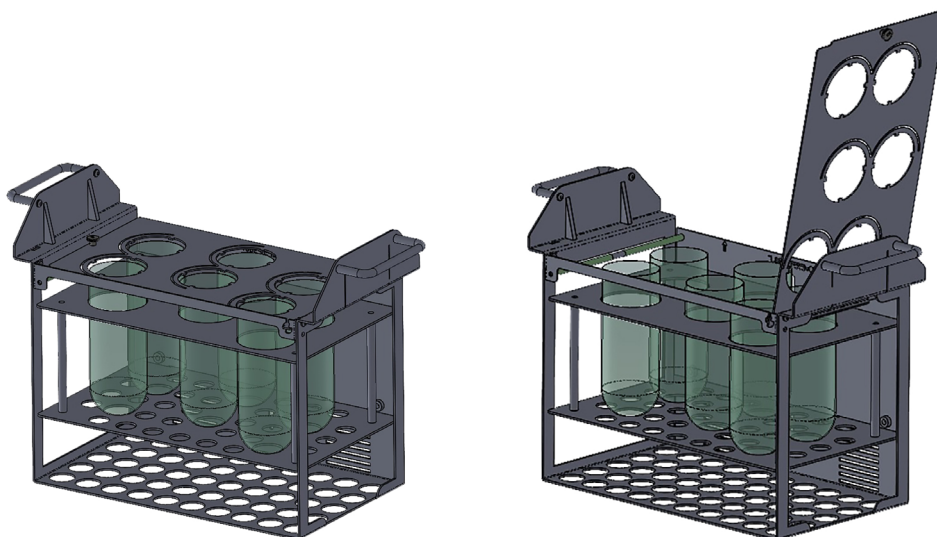

**The "All in one" computer:** The system is controlled by the central processing unit via a touch screen, which replaces the keyboard and the mouse.



## 1 - GENERAL DESCRIPTION

### Manifold:

The manifold (without nozzles) is delivered with a grid to hold the sample tubes in water bath.

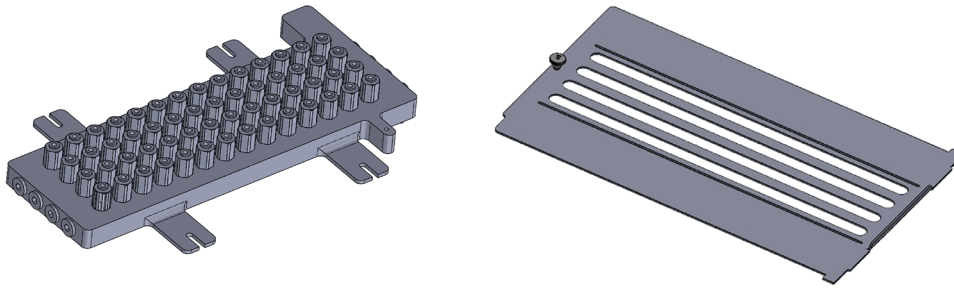

Each manifold can be connected/disconnected easily (More details in "**Installation**" part).



#### - Manifold – model n°1 (P/N: EVAA20): for 18mm/16mm OD tube sizes

Number of nozzles row: 4

Number of nozzles per row: 14

Max Capacity: Up to 56 samples

#### - Manifold – model n°2 (P/N: EVAA30): for 13mm (for puriFlash XS) OD tube sizes

Number of nozzles row: 5

Number of nozzles per row: 18

Max Capacity: Up to 90 samples



**Nozzles:**

Strong nozzles (stainless steel 316L – 0.7mm ID) are used to supply in gas each position. The nozzles are sold by 14 per bag (P/N: EVAA50).

**- Nozzle connection**

Manifold are equipped with quick connectors. A nozzle connected will be supply in gas. In other case, a damper inside the connector will close the gas when the nozzle is removed. To remove the nozzle, user pushes the black ring.



Position (with nozzle) – Damper is opened:



Position (without nozzle) – Damper is closed:

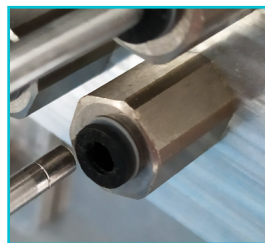

Interchim tool (P/N: EVAA60) enables to connect/disconnect more easily the nozzles.



Connect the nozzle:



Disconnect the nozzle:



**Bath:**

- Bath capacity: max 16 liters; min 13 liters
- Heating resistance (only the lower part heats)

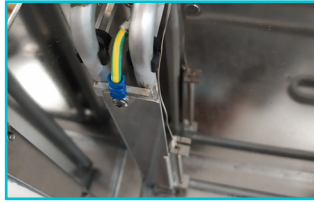

**- Protective grid**

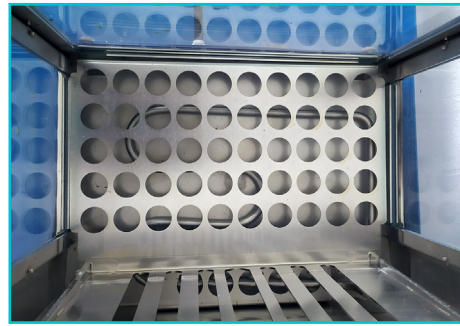

**- Quick connection to drain the water bath**  
"Drain" position: drain the bath

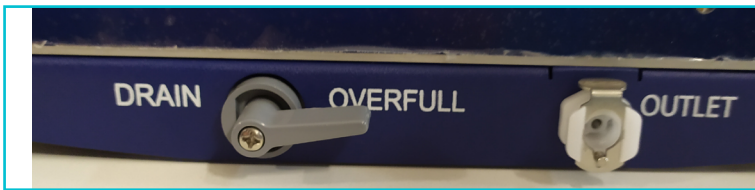

"Overfull" position: security if the level of water is too much.



**- Bath level detector**

If the water is under minimum level, the system stops the heating automatically, but the evaporation continues.



Two engravings in the front side of puriFlash XS-Vap indicate the max/low water bath level.



**- Temperature sensor**

The sensor indicates the water temperature. The software allows to calibrate the sensor.

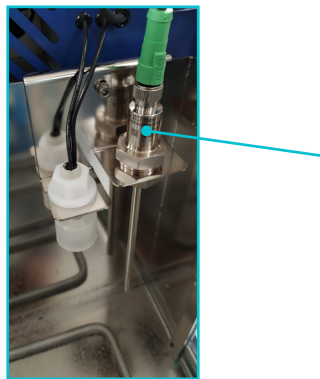

**- Bath Protection**

Protective cover can be removed to clean the external part of bath (unscrew four nuts). The system has to be switch off and the water bath temperature under 35°C before to remove the protection cover.



**- Bath light - Evaporator status**

Depending on the evaporator status (set parameters, heat the bath, evaporation finished ...), the light changes following the step.

The light increases the visibility inside the bath to control the samples during the evaporation process.

At any time, the user can turn on/off the light on the software.



LIGHT



LIGHT

Red light (flashing) alarm of security (bath level is under minimum level). The heating is stopped automatically, and a message indicates that the user must be filled the bath with water.

Blue light (flashing): evaporator is loading (or reset) parameters and/or water bath is heating.

Blue light (fixed): user is programming the parameters.



Blue & White lights (flashing): evaporator is ready to start.  
White light (fixed): evaporation is running

Green light (fixed): evaporation finished

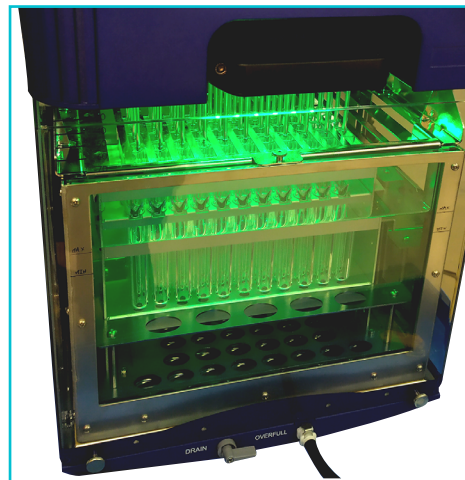
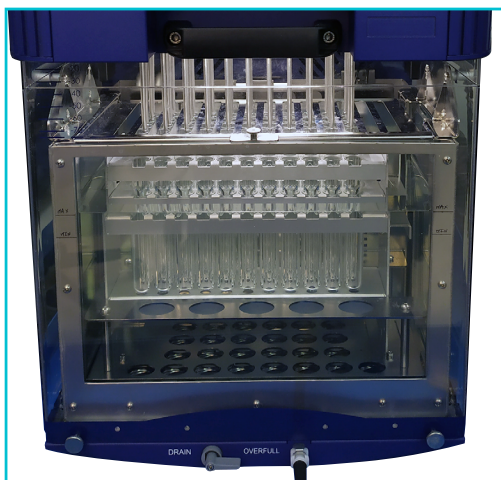

**Nozzle level adjustment:**

The user has the possibility to adjust the nozzle position thank to a manual wheel during the evaporation process. This technology decreases the gas consumption and increases evaporate rate. Two detectors inside the lid give the information on the software if the nozzle level is up or down position.

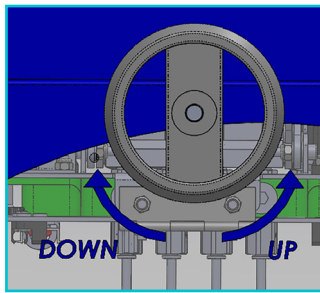
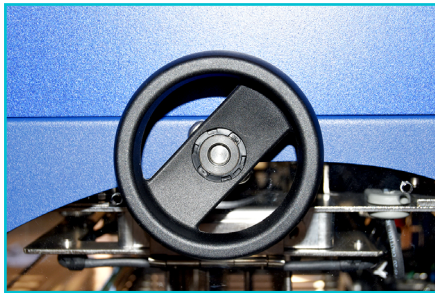

Detector n°1: the detector is inside the cover

Detector n°2: detection of position "up"

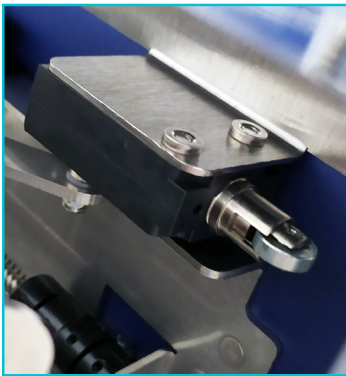

A scale front of the evaporator indicates the nozzle level. The nozzle can be decreased from 0 to 7cm (-70mm is the lowest level).

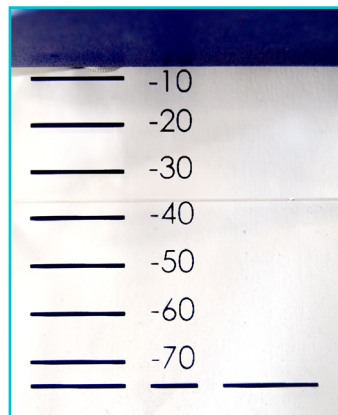

**Venting hose:**

To remove the solvent vapors, two exhaust fans total capacity :168m<sup>3</sup>/h is integrated on the rear of the evaporator. A venting hose (PN: EVAA70) can be connected to work outside of a fume hood. Venting hose isn't delivered with the system.

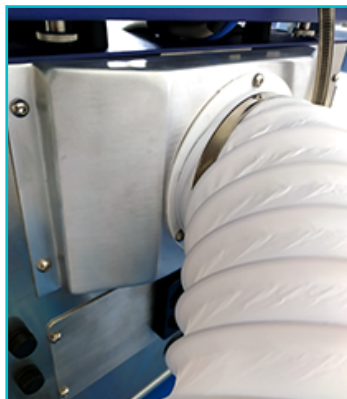

The system is delivered with:

- Protective grid
- Basket
- Drain and gas supply tubes



## 3 - INSTALLATION

### 3.1 - Unpack the system

Step 1:



Step 2:



Step 3:



Step 4:

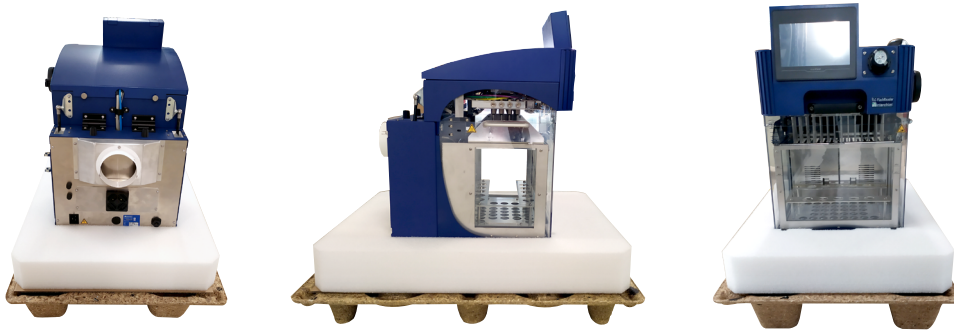

Step 5:

Lift the puriFlash® with two peoples on each side.

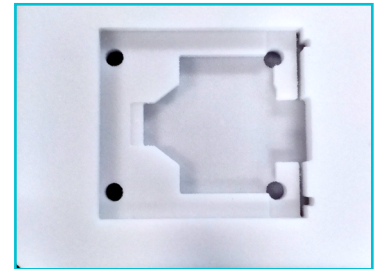
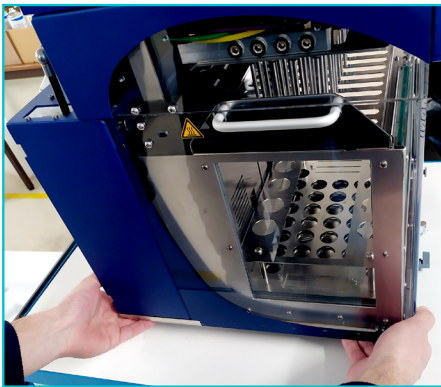

### 3.2 - Emplace the system

puriFlash XS-Vap must be installed on a firm and stable surface. (When the lid is open, the height is at 70cm)

### 3.3 - Electrical connection

Plug the electronic cord on the rear of puriFlash XS-Vap.



## 3 - INSTALLATION

### 3.4 - Gas connection

Plug the tubing 1/4" tubing to the pneumatic black fitting.

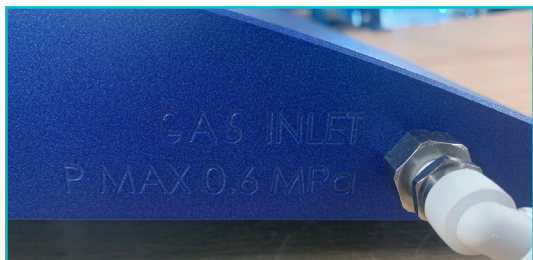

The maximum inlet pressure is 0.6MPa (6bar ; 87psi).

The gas is regulated by the manometer.

During evaporation, a pressure between 0.05MPa (0.5bar) to 0.15MPa (1.5bar) is enough.

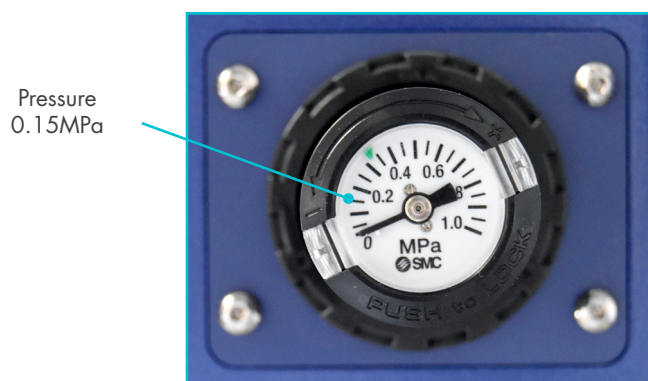

### 3.5 - Fill Water Bath

Step 1: turn the valve on this following position

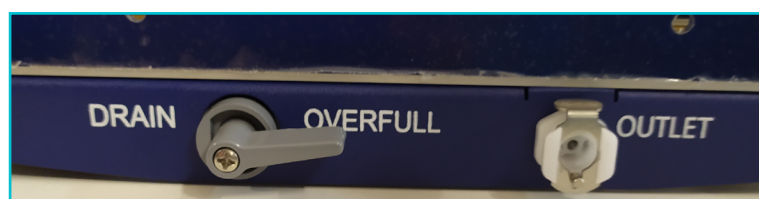

If the drain tube is connected, user can turn the valve on position "Overfull".

The bath has to be filled with deionized water. Fill the water bath level between "Min" and "Max".





### 3.6 - Connect the manifold

The manifold is delivered without nozzles

Step 1: open the lid

Step 2: turn the wheel to move down the manifold tool (up to the limit stop).

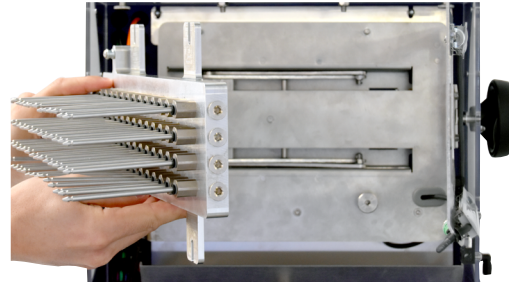

Step 3: set the manifold (this model is 4x14 nozzles for 18 & 16mm OD tubes)  
To set the manifold, user screws the 4 nuts.

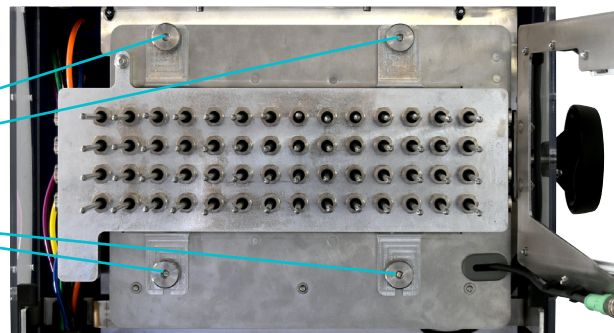
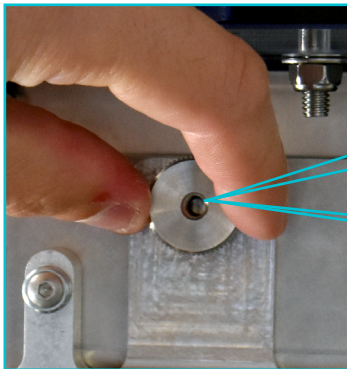

Step 4: connect each gas tubing to each channel. (each color tubing correspond of the fitting color).



Channel 1

Channel 2

Channel 3

Channel 4

Channel 5

Channel 6

Step 5: close the rail



## 4.1 - Control the system

Step 1: connect the manifold model according to the sample tube size and rack.

Step 2: connect the nozzles on each position where user will evaporate sample tubes.

Step 3: control the water bath level. (Between minimum and maximum level)

## 4.2 - Set up the system

Step 1: turn on the system (button is on the left side).



Step 2: click on "Clean" icon to switch on the software.

Step 3: set the heating temperature and click on the icon to heat the water bath (only if user need to heat the water). Set the temperature value.

The software indicates the setting temperature and the real water temperature inside the bath.

The system will heat the water bath up to the setting temperature value.

The water bath flashes in blue light during the heating and fixed blue when the temperature reaches the setting value.



HEAT

15.0 °C

SET TEMP. VALUE 40.0 °C



40.0 °C

SET TEMP. VALUE 40.0 °C



Step 4: select the manifold model.

### NOOZLES

Rack test tubes: for 13,16 and 18mm OD tubes

Rack glassware: for 200mL glassware

Rack test tubes

Rack glasswares

Step 5: select the rows to supply in gas. Click on EV6 to EV1 to select.

For rack test tube (up to 5 rows):

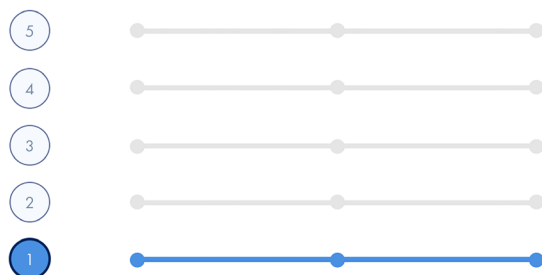

## 4 - OPERATION

For rack glassware 200ml (up to 6 rows):

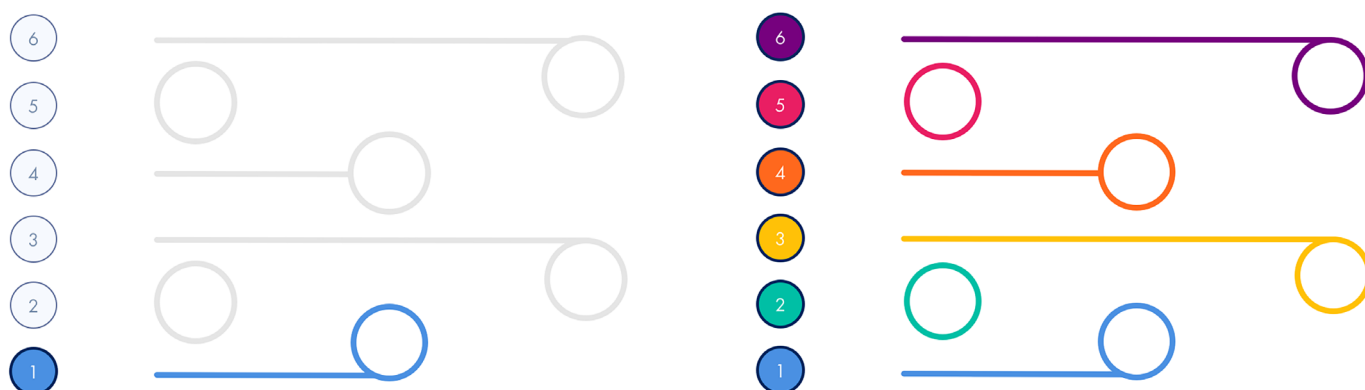

Step 6: select the program. Click on icon «manual» or «Timer».

Timer: user indicates the evaporation time. When the evaporator reaches the end time, he closes each rows selected. The bath is fixed green light.

Manual: user launches the evaporation process without evaporation time.

For «Manual» and «Timer», user can stop the evaporation at any moment.

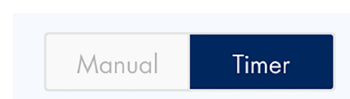

### 4.3 - Start a run

A message indicates that the system is ready to start and the light flashes in blue and white, user can click on .

If the water is reaching the setting water temperature (water temp. < setting temp.), user has to wait (message indicates the informations).

The nozzle position is manually adjusted according to the sample volume and the gas pressure. (please check the pressure table in pages 4 & 5).

When the nozzle moves down, the software indicates the nozzle position:



The gas flow creates a sample homogeneity and rinses the tube wall. The gas pressure needs to be regulated to avoid solvent projections.

The nozzle and the sample surface must keep a gap of more than 1 cm to reduce the risk of projections due to the gas flowrate.

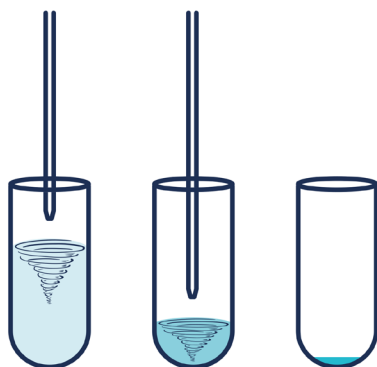

During the evaporation process, the sample volume will decrease. To keep the evaporation rate, the needle position can be decrease as you go along up to the level -70.

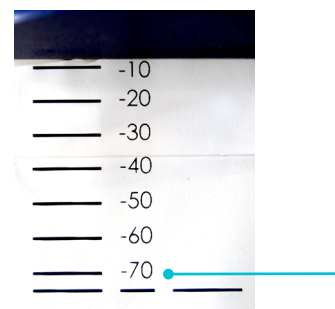

At any time, the user can stop or pause the evaporation.

To abort an evaporation: click on  , increase the nozzle position up to nozzle status « up » and click on  or open the lid.

To pause an evaporation: click on  , increase the nozzle position up to nozzle status « up » and open the lid.

To restart the system, close the lid, click on  and decrease the nozzle position.

The evaporation is automatically paused (gas off) when the lid is opened and restart when the lid is closed.

### 4.4 - End of run

With « Timer », the evaporator will stop automatically stop the system.

With « Manual », the evaporator will be stop by the user.

At the end of evaporation process, the bath light is fixed green.

For both modes, user increases the nozzle position up to nozzle status

« up » and click on  or open the lid.

When the evaporator is stopped, the heating continues.

To remove sample tubes, take the basket by the handles.

Hooks at the rear of the basket allow to dry the rack.

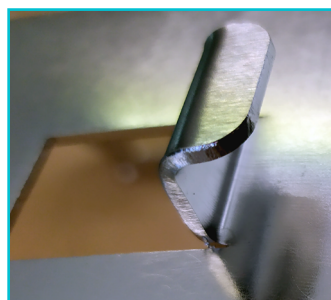

To turn off the system, click on

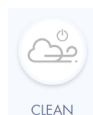

, click on the button



and open the lid.

This equipment is built according to the E.U. security standards. However, risks and dangers could remain if the system is used in a different way from which it is intended or if it is used by untrained personnel. The puriFlash® XS-Vap device should only be used by laboratory trained or experienced persons. The user should inform the distributor in case of problems and safety-related matters that occur during the use of the instrument.

This system is designed for evaporation purposes. It must be operated using appropriate solvents and gas (nitrogen or air compressed with oil filter). If it is used in a manner not specified by the manufacturer, the protection provided by the equipment may be impaired.



*When handling potentially hazardous solvents and samples, it is important to follow standard laboratory safety procedures. Common chemicals used in the laboratory can be toxic, corrosive, flammable, biohazard or a combination of these properties.*

A list of all safety aspects is outside the scope of this manual, but the following points should be considered:

- >> Ensure adequate ventilation,
- >> Wear eye protection,
- >> Wear gloves when handling chemicals,
- >> Ensure all liquid containers are secure,
- >> No smoking or naked flames,
- >> Clean-up all spillages...



*Eye damage could occur from particles or chemicals.  
Use proper eye protection.*



*Hazardous voltages are present inside the instrument.  
Disconnect from main power before removing screw-attached panels.*

Removal of protective panels may only be performed by an authorized person. When it is necessary to use a non-original power cord plug, make sure the replacement cord adheres to the color-coding and polarity described in the manual and local building safety codes. Replace blown fuses with fuses of the size and rating stipulated in the manual. Replace faulty or frayed power cords immediately with the same type and rating. Make sure that voltage sources and line voltage match the value for which the instrument is wired.

To ensure your own safety, thus of your co-workers, and safe operation of the equipment, observe the following instructions:

- >> Use a 3-wire mains socket with ground connection, grounding is necessary to ensure operator safety and proper operation.
- >> Take care of inflammable solvents.
- >> Before moving the instrument, the external connections have to be disconnected



Take care to avoid injury to hands when in the vicinity of equipment with closing mechanical parts.



Check user manual – Alerts you to potential hazardous situations that could result in serious injury or damage of the system.



Potential burn hazard due to hot surface. Do not touch.



Ethernet port. Please refer to 6.7 - Update the control unit.



Electrical Grounding.

Safety terminal is connected to an external conductor for protection against electric shock in case of a fault (n°5019 – CEI 60417).

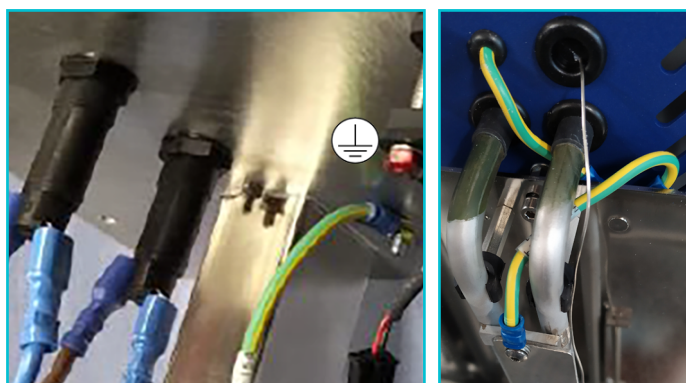

## 6 - MAINTENANCE

### 6.1 - Clean the nozzles

The nozzles has to be cleaned with a non-alkaline detergent. The nozzle should be replaced only if she's broken or clogged.

### 6.2 - Clean the manifold

Disconnect the manifold (section 3.6 - Connect the nozzle rows) and clean with a non-alkaline detergent.

To replace a quick connector, use a flat key or hexagon socket wrench. The connector should be replaced only in case of leakage.

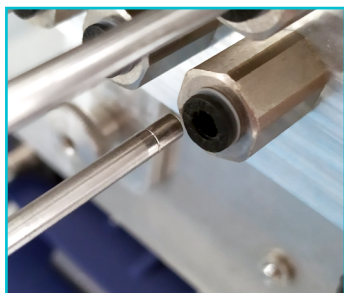

### 6.3 - Clean the water bath:

To avoid the risk of burning, the water must be lower than 35°C. Turn off the system and disconnect the power cord.

Clean the water bath once per week (depending on use).

Step 1: remove the basket.

Step 2: connect the drain tube and turn the valve on position « Drain ». Place the drain tube in a waste canister (around 15L.)



Step 3: clean the bath walls with a cleaning solution.

Step 4: rinse the bath walls.

Step 5: fill the bath with deionized water up to level «low» at minimum.



### 6.4 - Clean the system

Switch off the system and disconnect the power cord.  
Clean the external parts with a cloth dampened with ethanol or isopropanol.  
The screen can be clean with a soft cloth. Take attention to avoid solvents.

Protective cover is disconnected by unscrewing 4 nuts (take attention if the water bath is above 35°C).

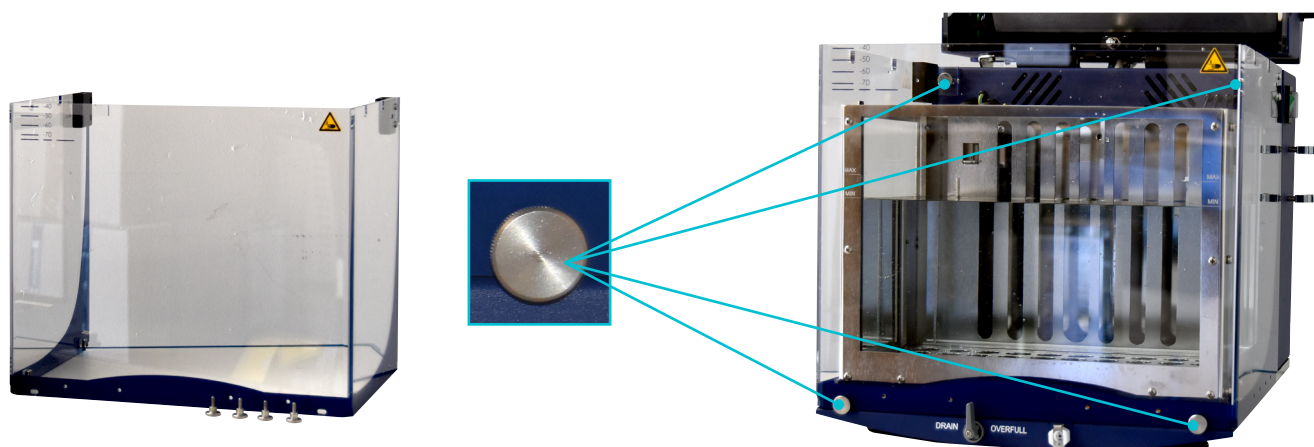

### 6.5 - Long storage

Switch off and disconnect the power cord.  
The bath must to be drained and cleaned. Clean the nozzles if necessary.  
Close the lid.

### 6.6 - Heating temperature calibration

This option is dedicated to control the gap between the temperature sensor and a thermometer especially for the metrology control.

Step 1: place a thermometer inside the bath.



Step 2: Turn Off the heating bath

Step 3: Click on 

A window allows to fix the gap between the water temperature indicated by the puriFlash® XS-Vap sensor and the thermometer.

Add the value and click on Enter. The system takes in memory the gap when the user will heat the bath.

Example:

The setting temperature value is 40°C  
The puriFlash® XS-Vap indicates 40°C.  
The thermometer indicates 41.5°C.

The value is 1.5°C between each temperature. So the user indicates 1.5°C (after turn off the heating) and click on enter.  
When the setting temperature value will be at 40°C, the system will heat up to 40°C taking into account the calibration of the probe. If the user places the thermometer inside the water bath, the temperature will be at 40°C.

### 6.7 - Update the control unit

Ethernet port on the rear of the puriFlash XS-Vap is dedicated to update the control unit. Only AIS service team is authorized to connect ethernet cord.

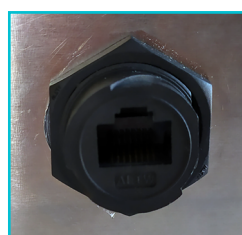

## 7 - PREVENTIVE MEASURES UPKEEP SCHEDULE

By considering the use of clean solvents and all precautions already mentioned in the chapter "6/Maintenance", here is a table which regroup the recommended actions to assuring a good working of the system:

Operation	Frequency
<b>Bath</b>	
Check the bath tightness	Yearly (or when damaged parts are observed)
Clean the bath	Weekly
Drain the bath	Weekly
<b>Lid</b>	
Check the manual wheel and mechanism	Quarterly (or when higher noise levels)
Check the gas supply and tubings on each row	Quarterly (or when abnormal pressure/ flow rate)
Check the gas valves (inside the lid)	Quarterly (or when abnormal pressure/ flow rate)
<b>Nozzles &amp; Manifold</b>	
Clean the nozzles	As soon as possible
Replace the nozzles	Only if the nozzles are broken or clogged
Replace quick connectors	Yearly (or when damaged parts are observed)
Clean the manifold	Quarterly
<b>General</b>	
Verify the cleanliness	Daily
Use only a dry cloth to clean external part of the system	Weekly
Check the fans working to maintain a good air recycling inside the system	Monthly

Interchim® guarantees the Puriflash® XS-Vap for one year for parts and labor at the discretion of Interchim® in normal conditions of use and installation from the date of signing of the installation report by the service provider approved by Interchim® to install the machine and by the customer.

The Puriflash® XS-Vap is guaranteed against material and manufacturing defaults in normal conditions of use by approved professionals and within the technical characteristics compatible with the functions defined in the user manual.

**Terms and conditions of the guarantee:**

- The device is only guaranteed if installed by a service provider approved by Interchim®.
- The guarantee covers the supply of parts found defective by Interchim® free-of charge, as a minimum, within the limits of the wear parts listed in part 9.
- The device must have been used with the consumables recommended by Interchim®.

**Guarantee exclusions:**

- The guarantee will not cover devices installed by the customer or by a service provider not approved by Interchim®.
- The guarantee will not cover device problems linked to the use of software (antivirus, applications,...) installed by the customer or by a service provider not approved by Interchim®.
- The guarantee will not cover equipment used in a manner which is noncompliant with the provisions in the instructions.
- The guarantee will not cover equipment subject to interventions, repairs or modifications by personal without Interchim® approval.
- The guarantee will not cover parts modified or changed by the customer or the service provider without Interchim's approval.
- The guarantee will not cover parts damaged by this modification.
- The guarantee will not cover parts not recommended by Interchim®.
- The guarantee will not cover any wear parts (listed in part 9), consumables and any other parts that comes in contact with the sample path.
- The guarantee will not cover electrical and/or electronic and/or IT incidents caused by external factors.
- The guarantee will not cover damage caused to the software or hardware due to contamination by an IT virus.
- The guarantee will not cover damage or failures caused by environmental conditions (part 10.2) and lack of maintenance.
- The guarantee will be cancelled in case of damage caused by abnormal mechanical forces applied to the device and exceeding the limits defined in the user manual.
- The guarantee will be cancelled in case of corrosion to the device due to solvent leakage or samples.
- The guarantee will be cancelled in case of corrosion to electronic components caused by highly corrosive gas.
- The guarantee will not cover damage or failures caused by assembly, dismantling, modification or transport after initial installation by service provider approved by Interchim®.
- The guarantee will be cancelled in case of failure or damage due to noncompliance with the closing and shutdown procedure for the device.
- The guarantee will be cancelled in case of failure or damage due to wrong installation.
- The guarantee will be cancelled in case of failure or damage due to wrong AC power supply.
- The guarantee will be cancelled in case of failure or damage due to noncompliance with safety procedures.
- The customer is liable for transport risks. In case of damage during transport, the beneficiary must issue all reserves to the transport firm before accepting the delivery of the device.
- The guarantee will not cover damage caused by: accidents, external events, contingencies, natural disasters or force majeure, due to negligence, or a lack of surveillance by the customer or due to non-compliance with safety rules.
- The guarantee will not cover damage if the maintenance procedures recommended by the manufacturer are not complied with. Interchim® will not guarantee the results of the use of the Puriflash® XS-Vap.
- The guarantee will be cancelled in case of resale of Puriflash® XS-Vap as part of a new set not approved by Interchim® before.

Part Number	Designation	Qty/ pack	Wear Parts	Recommendation: Normal Use		Recommendation: Intensive Use	
				12 months	24 months	6 months	12 months
	Quick connector for nozzle	10	no	x		x	
EVAA50	Nozzle	14	no	x		x	
	Right drop system	1	no		x		x
	Left drop system	1	no		x		x
	Front protective cover	1	yes		x		x
	Socket kit	1	yes		x		x
	Basket kit	1	yes		x		x

## 10.1 - General Safety Instruction

### EU Declaration of Conformity

This device complies with the following EC Directives\*:

- 2006/42/EC Machinery Directive
- 2014/30/EU Electromagnetic Compatibility Directive

\*Also see attachment "EU Declaration of Conformity".

**The device has been constructed according to state-of-the-art technology and recognized safety regulations. However, there are still risks involved with installation, operation, and maintenance.**

- Please ensure the operating manual is always available.

### The device may only be used under the following circumstances:

- Only operate the device if it is in full working order.
- Ensure all operators of the device possess the necessary safety and risk awareness.
- Only operate the device in accordance with the instructions given in this manual.
- If there is anything you do not understand, or certain information is missing, ask your manager or contact the manufacturer.
- Do not do anything on the device without authorization.
- Only use the device in accordance with its intended use.
- The heating bath temperature has to be lower than the solvent boiling point. The minimum gap is of 6-7 °C.
- The inlet pressure must keep under 6bar.

### Intended use

**The device is intended for use by trained and authorized personnel only.**

This system is designed for evaporation purposes. It must be operated using appropriate solvents and within specified ranges for pressure, flows and temperatures as described in this manual. If it is used in a manner not specified by the manufacturer, the protection provided by the equipment may be impaired.

The system is compatible with all common organic solvents.

**The operation for the device is suitable in any of the following locations:**

In any Research application.

Improper use:

Any use which deviates from the device's intended use is considered to be improper use. The manufacturer does not accept liability for any damages resulting from improper use. The risk shall be borne solely by the operator.

### Installation/electrical safety

- The device may only be connected if the mains voltage corresponds with the information on the type of plate.
- The mains connection must be easily accessible at all times.
- Repairs may only be performed by a qualified electrician.
- Never operate the device with a damaged power cord.
- Always turn the device OFF and disconnect mains power before performing any maintenance or service.
- The device can be used outside of fume hood, but the exhaust tube must be connected to a ventilation. Never use the device outside of fume hood without security requirements.
- The device can be used inside a fume hood without exhaust tube.

### Personnel qualification

- The device may only be operated by trained and qualified personnel.
- The device may only be operated by users who have been instructed in its proper use by qualified persons.
- The device must not be operated by persons below the legal minimum age.
- Other personnel may only work on the device under the continuous supervision of an experienced and qualified operator.
- This manual must be read and understood by all persons working with the device.
- The personnel must receive safety instruction to guarantee responsible and safe operating procedures.

## 10.2 - Operating company's obligations

### Installation site

- The device must be positioned in a suitable location.
- The device must be installed on a firm and stable surface.
- All screw connections must be securely tightened.
- When working with flammable solvents, always ensure a proper ventilation to prevent from flammable, explosive conditions. Carefully check safety information on solvent bottles' label before to use them and their Material Safety Data Sheet.
- Installation and operation of the device is only permitted in facilities which are equipped with appropriate laboratory equipment (e.g. with extractor hoods).
- Only operate the device in conjunction with an extractor hood (at least 10-fold air change, with error monitoring), if working with potential harmful media (see DIN EN 14175 and DIN 12924).
- The device may only be operated in enclosed spaces and under the following ideal environmental conditions:
  - Power distribution: TT or TN power system only, transient over-voltages according to installation category II, Class 1 equipment, require mains socket plug with protective earth terminal.
  - IP Code: IP20
  - Temperature: 10 to 40°C
  - Relative Humidity: 0 to 80% (non-condensing)
  - Others: Indoor use, Altitude 0 up to 2000 m above sea level
  - Pollution degree 2, Noise level < 60 dB.

Dimensions: 37x60x40cm (WxHxD with connection)

Weight: 35kg (2 persons required for its handling)

- If the equipment is used in corrosive atmospheres, the service life of the equipment will decrease based on concentration, volumes, and frequency of exposures to these corrosive materials.

### Modifications to the device

- No unauthorized changes may be made to the device.
- Removal of protective panels may only be performed by an authorized person. When it is necessary to use a non-original power cord plug, make sure the replacement cord adheres to the color-coding and polarity described in the manual and local building safety codes. Replace blown fuses with fuses of the size and rating stipulated in the manual. Replace faulty or frayed power cords immediately with the same type and rating. Make sure that voltage sources and line voltage match the value for which the instrument is wired.
- No parts may be added or inserted which have not been approved by the manufacturer.
- Unauthorized changes shall void the EC Declaration of Conformity and the device must not be operated any more.
- The manufacturer shall not be held liable for any damage, danger or injuries resulting from unauthorized changes or from operating the device other than as described in this manual.

### Personnel safety

- Ensure that the device is only operated by qualified personnel.
- Observe the following regulations:
  - Laboratory rules
  - Accident prevention regulations
  - Hazardous Substances Act
  - Other generally accepted occupational health and safety regulations
  - Local rules and regulations
- When handling potentially hazardous solvents and samples, it is important to follow standard laboratory safety procedures. Common chemicals used in the laboratory can be toxic, corrosive, flammable, biohazard, or a combination of these properties.



### 10.3 - Lid handling

To open and close the lid, place your hand in this position.



To close the lid, be careful to remove your hand between the protective cover and the lid.

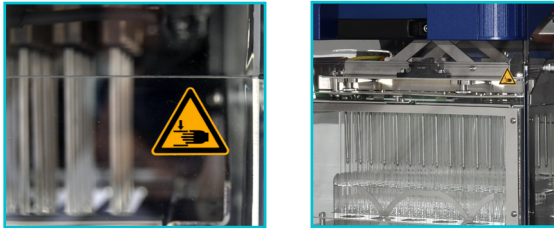

If the lid is open and the nozzle position is « down », the user can't close the lid. This option secures the sample tubes.

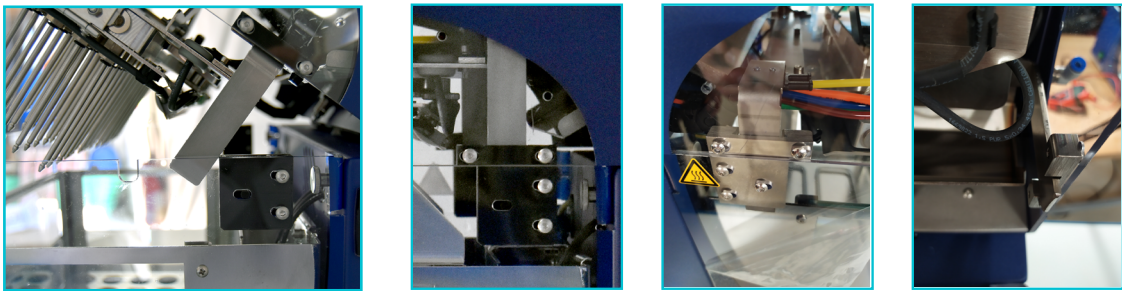

In other case, if the user wants to open the lid during the evaporation process and the nozzle position is down, the lid can't be open. The nozzle must be in position « up » to open it.

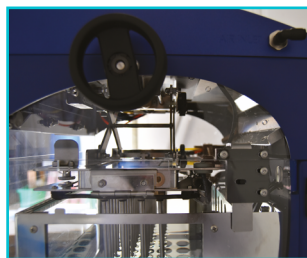

### 10.4 - Heating

The heating bath temperature must be below of 6-7°C than the solvent boiling point. A pictogram indicates the risk of burns if the user touches the water bath walls inside. Protective part secures.

Never remove the protection when the system is switch on and the water bath temperature is higher than 35°C. User must be switch off the system and wait few minutes to reach a temperature lower than 35°C.

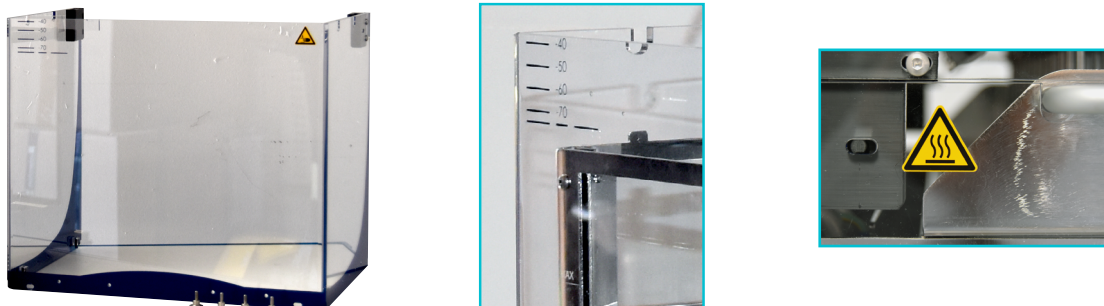

Several holes on the protective cover allows an air circulation inside the system. The protective cover has a low temperature with the user touches it.



The top of the heating resistance isn't heated.



A grid protects the heating resistance. The grid can be removed easily. Never remove the grid if the device is switch on and the bath is heating. To remove the grid, the temperature must be lower than 35°C and the system switches off

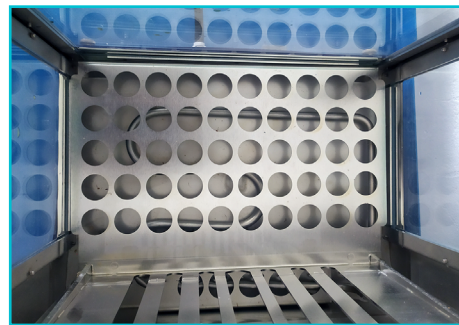

The bottom of the system is isolated.



### 10.5 - Water leakage

If the bath has a leakage or spill water outside, the system has a gutter all around the bath with several evacuations. Leakages cannot reach the electrical parts.





If the water bath is overfull, an outlet for draining is integrated inside the bath. The valve must be in position «Overfull» and the tubing connected to a canister.



### 10.6 - Exhaust fan

Two exhaust fans (168m<sup>3</sup>/h) on the rear of evaporator remove the solvent vapors during the evaporation. Grids protect the exhaust fans of materials which could be blocks them. Never try to open or touch the exhaust fans when the system is on.

Take attention to keep a distance of 30cm behind the unit to avoid blocking the ventilation.

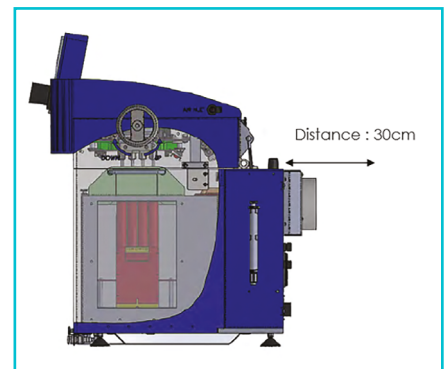

### 10.7 - Electrical power connection



Unplug the unit directly from the back of the unit or from the wall socket.

### 10.8 - Condensation

The lid must be open when the exhaust fan is turn off and the water bath temperature is higher than 35°C. In case of the lid is closed, water bath is hot and the exhaust fan is turn off, we can have condensation inside the lid.

The lid is equipped with a drip tray to collect the water condensation when user opens the lid. By closing the lid, the water condensation flows in the water bath.



### 10.9 - Regulation gas pressure

Always keep a gap more than 1 cm between the sample surface and the needle to reduce the risk of projection outside the tubes. To set the pressure, turn the manometer and push the wheel to block it. To change the pressure, pull the wheel.

Please refer to the gas pressure table to choose the right value.



# 11 - SPECIFICATIONS

 S.A.S  
211 Avenue J.F. Kennedy  
03100 Montluçon - France

Made in France

Type:	<i>puriflash</i> XS-Vap
SN:	
Volt:	100-120 VAC
Fuse:	T20A H 250V
Frequency:	50-60 Hz
Power:	2000 W

US version

 S.A.S  
211 Avenue J.F. Kennedy  
03100 Montluçon - France

  

Made in France

Type:	<i>puriflash</i> XS-Vap
SN:	
Volt:	220-240 VAC
Fuse:	T20A H 250V
Frequency:	50-60 Hz
Power:	2000 W

EU version

 : The CE mark indicates that the product complies with European standards of health, environmental protection and safety and can be freely sold in the European Economic Area and Turkey.

 : Symbol indicating that the device should not be discarded in household rubbish; it must be collected by a specific industry.

**Model name:** Interchim® "XS-Vap" series

**Serial number:** PF-XSVAP-XXXX

**Maximum Operational Pressure:** 2bar (0.2MPa , 29psi) during process (6bar (0.6MPa ; 87psi) maximum inlet pressure)

**Control:** via touch screen

**AC mains supply voltage:** 220-240 VAC +/-10% ; 50-60 Hz or 100-120 VAC +/-10% ; 50-60Hz

**Electrical protection:** Delayed action fuse T20A H 50V for 220-240VAC and 100-120 VAC

**Power:** 2000 Watts.

**Power distribution:**

**IP Code:**

**Weight:** 35kg (2 persons required for its handling - system + packaging around 39kg)

**Temperature:** 10°C to 40°C

**Relative Humidity:** 0 to 80% (non-condensing)

**Exhaust fan:** 168m<sup>3</sup>/h

**Fuse:** T20A H 250V

Foot print:

Width 1 (with basket handles): 42cm

Width 2 (without gasket): 37cm

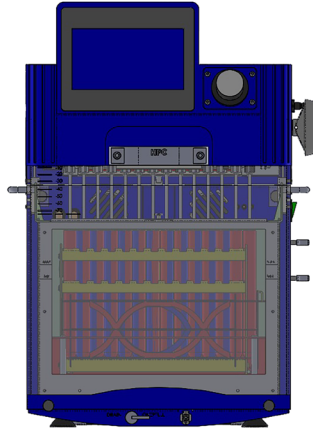

Depth 1 (with venting hose option): 46cm

Depth 2 (without venting hose option): 40cm

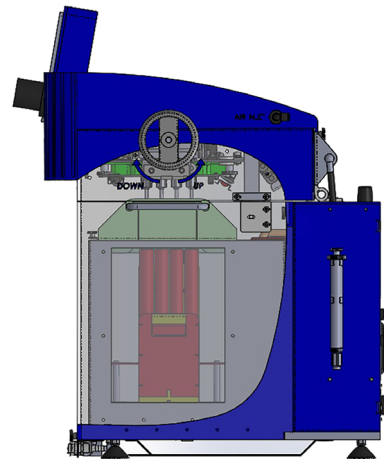
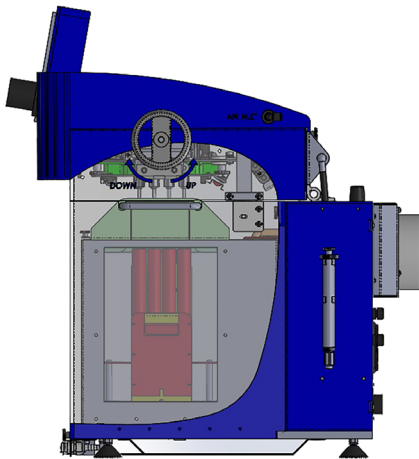

Height 1 (with lid open): 70cm

Height 2 (with lid close): 60cm

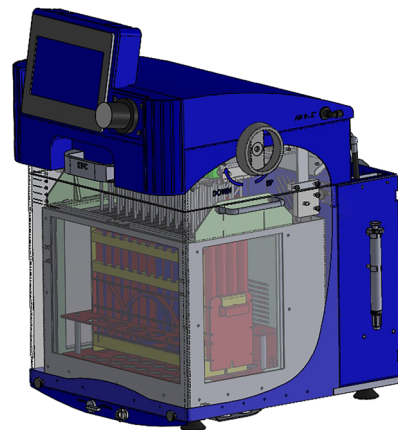
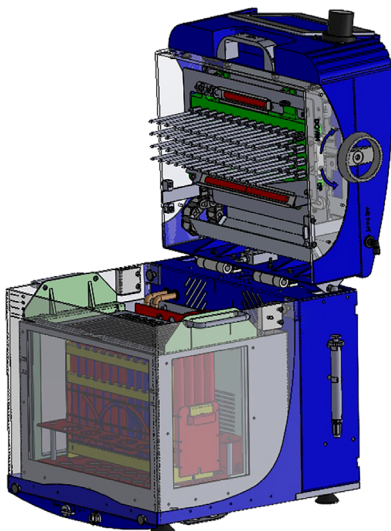

## Service report

- |                                       |  |
|---------------------------------------|--|
| <input type="checkbox"/> Installation | <input type="checkbox"/> End of warranty visit |
| <input type="checkbox"/> Repair       | <input type="checkbox"/> Maintenance           |

- |  |
|--|
| <input type="checkbox"/> Warranty        |
| <input type="checkbox"/> Out of warranty |

System description: .....

S/N: ..... Module:.....

Service action: .....

.....

.....

P/N and description of defective spare part:.....

.....

Any further action required: .....

.....

Date: ..... Name: ..... Signature:

## Service report

- |                                       |  |
|---------------------------------------|--|
| <input type="checkbox"/> Installation | <input type="checkbox"/> End of warranty visit |
| <input type="checkbox"/> Repair       | <input type="checkbox"/> Maintenance           |

- |  |
|--|
| <input type="checkbox"/> Warranty        |
| <input type="checkbox"/> Out of warranty |

System description: .....

S/N: ..... Module:.....

Service action: .....

.....

.....

P/N and description of defective spare part:.....

.....

Any further action required: .....

.....

Date: ..... Name: ..... Signature:

## Service report

- |                                       |  |
|---------------------------------------|--|
| <input type="checkbox"/> Installation | <input type="checkbox"/> End of warranty visit |
| <input type="checkbox"/> Repair       | <input type="checkbox"/> Maintenance           |

- |  |
|--|
| <input type="checkbox"/> Warranty        |
| <input type="checkbox"/> Out of warranty |

System description: .....

S/N: ..... Module:.....

Service action: .....

.....

.....

P/N and description of defective spare part:.....

.....

Any further action required: .....

.....

Date: ..... Name: ..... Signature:

## Service report

- Installation
- Repair

- End of warranty visit
- Maintenance

- Warranty
- Out of warranty

System description: .....

S/N: ..... Module:.....

Service action: .....

.....

.....

P/N and description of defective spare part: .....

.....

Any further action required: .....

.....

Date: ..... Name: ..... Signature:

## Service report

- Installation
- Repair

- End of warranty visit
- Maintenance

- Warranty
- Out of warranty

System description: .....

S/N: ..... Module:.....

Service action: .....

.....

.....

P/N and description of defective spare part: .....

.....

Any further action required: .....

.....

Date: ..... Name: ..... Signature:

## Service report

- Installation
- Repair

- End of warranty visit
- Maintenance

- Warranty
- Out of warranty

System description: .....

S/N: ..... Module:.....

Service action: .....

.....

.....

P/N and description of defective spare part: .....

.....

Any further action required: .....

.....

Date: ..... Name: ..... Signature:

## Service report

- Installation
- Repair

- End of warranty visit
- Maintenance

- Warranty
- Out of warranty

System description: .....

S/N: ..... Module:.....

Service action: .....

.....

.....

P/N and description of defective spare part: .....

.....

Any further action required: .....

.....

Date: ..... Name: ..... Signature:

## Service report

- Installation
- Repair

- End of warranty visit
- Maintenance

- Warranty
- Out of warranty

System description: .....

S/N: ..... Module:.....

Service action: .....

.....

.....

P/N and description of defective spare part: .....

.....

Any further action required: .....

.....

Date: ..... Name: ..... Signature:

## Service report

- Installation
- Repair

- End of warranty visit
- Maintenance

- Warranty
- Out of warranty

System description: .....

S/N: ..... Module:.....

Service action: .....

.....

.....

P/N and description of defective spare part: .....

.....

Any further action required: .....

.....

Date: ..... Name: ..... Signature:



# Advion Interchim

scientific

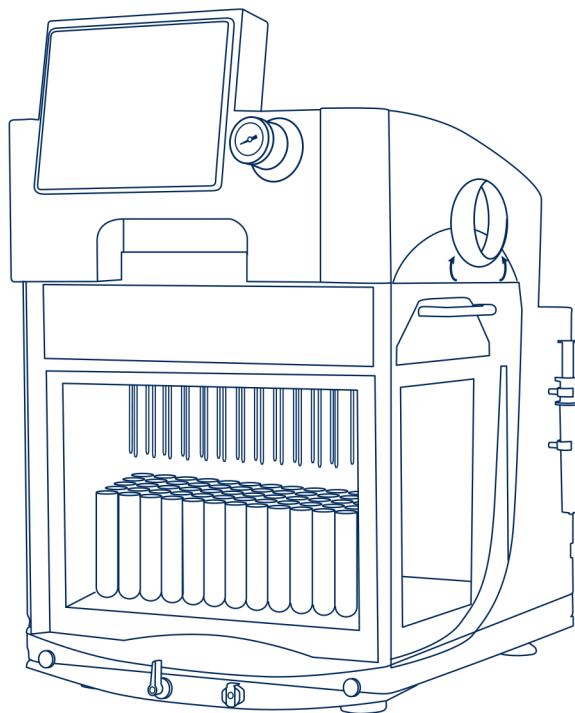

## Imprint

Product Identification:

User Manual, puriFlash® XS-Vap

AIS-ITM-20210507-E

Publication date:

06.2021, Version 1

Interchim®

211 Bis avenue J.F. Kennedy - BP 1140

03100 Montluçon Cedex - FRANCE

Phone: +33 470 038 855

Fax: +33 470 038 260

Email: [interchim@interchim.com](mailto:interchim@interchim.com)

Web site: [www.interchim.com](http://www.interchim.com)

[www.flash-chromatography.com](http://www.flash-chromatography.com)



Interchim® reserves the right to make changes to the manual as deemed necessary in the light of experience, especially in respect to structure, illustrations and technical detail.

This manual is copyright. Information from it may not be reproduced, distributed, or used for competitive purposes, nor made available to third parties.

The manufacture of any component with the aid of this manual without prior written agreement is also prohibited.

Advion Interchim Scientific is the market-facing name of a partnership between Advion, Inc. and Interchim SAS, separate companies that have agreed to market and distribute their products together.